

Rev. No.	Revision Note	Date	By	Checked
A13	REVISED INPUT AND OUTPUT TERMINALS	09-MAR-2015	CG	YD
A14	REVISED OPEN STYLE FOOT BRACKET	06-SEP-2019	CG	AH

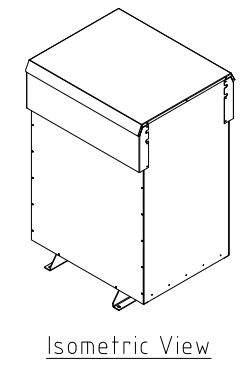

Connection Diagram

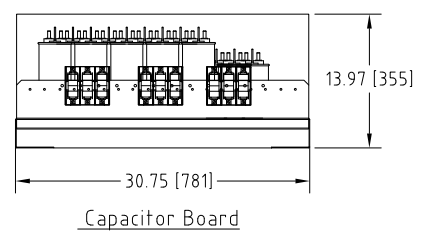
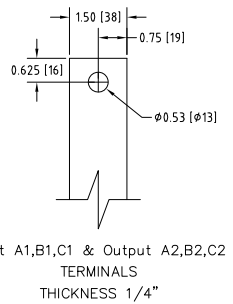
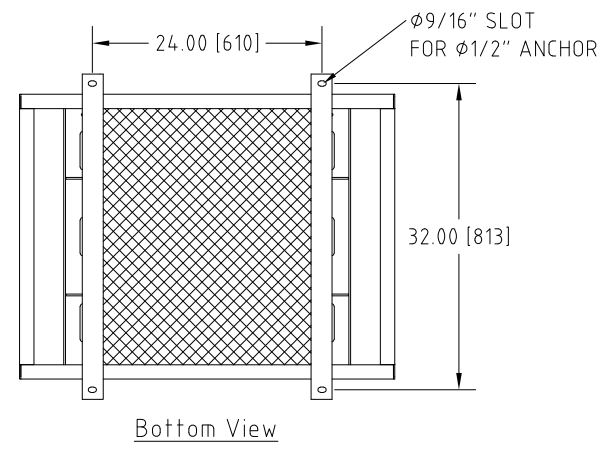
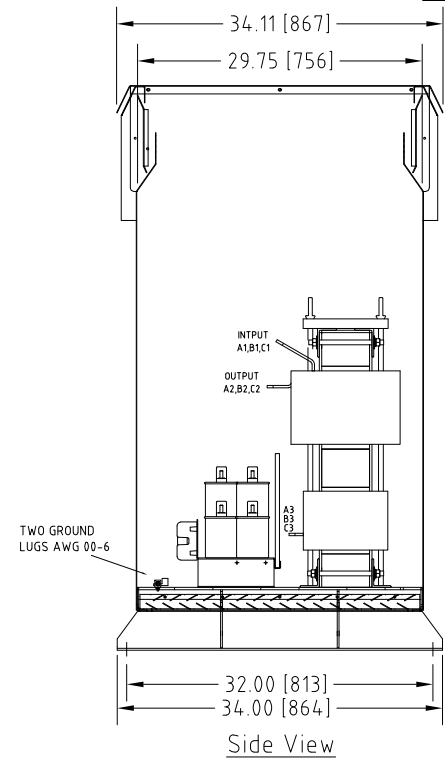
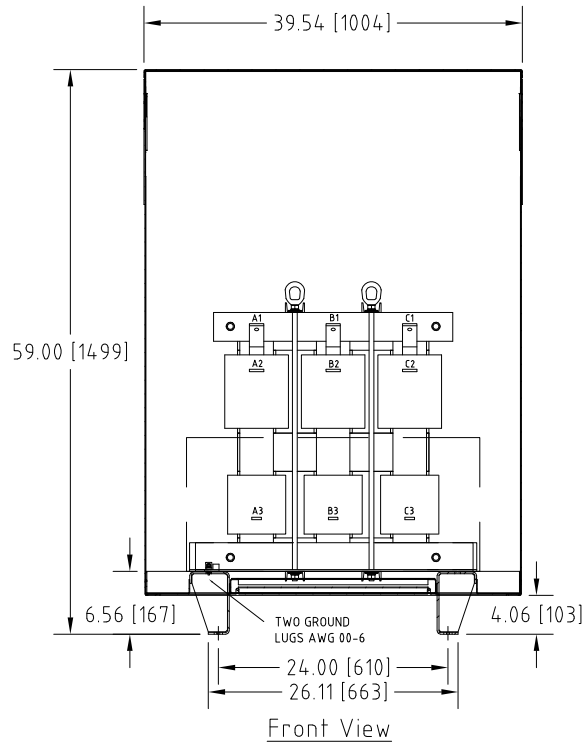
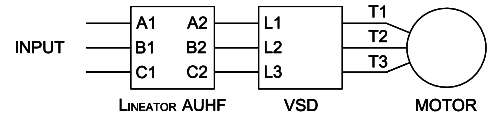

UNIT SPECIFICATIONS				INPUT	OUTPUT	APPROX. WT
HP [kW]	PHASE	VOLTS	Hz	AMPS	kW	lb [kg]
400 [315]	3	600	60	375	349	1031 [467]

NOTES:
 1. Customer is responsible for installation to meet all national and local electrical codes and other applicable electrical safety authorities.
 2. NEMA 3R Enhanced enclosure suitable for outdoor installation. Only front access is required but minimum 6" clearance should be provided at rear for proper ventilation.

MIRUS International Inc. #12-6805 Invader Cres., Mississauga, ON, Canada L5T 2K6
 Tel:(905) 565-6900 Fax: (905) 565-6911 Toll Free: 1-888-TO MIRUS

Unless otherwise specified, dimensions are in inches and [mm].	Drawn By CW	Date Created 01-Jun-08	Checked by YM	Approved by - date YM-01-Jun-08	Scale NTS
The information contained herein is the sole property of MIRUS International Inc. Any form of reproduction, distribution and/or disclosure of this information, all or in part, is strictly prohibited without the express written consent of MIRUS International Inc.			Title 400 HP, 600 V, 60 HZ LINEATOR™ AUHF (Nema-3R Enh.)		
Filename AUHF-400-600-60-D-E1E-A14			Revision A14	Sheet 1/1	