

Rev. No.	Revision Note	Date	By	Checked
A23	REVISED CAPACITORS	13-FEB-15	CG	AH
A24	REMOVED ENHANCED ENCLOSURE UNISTRUT ADAPTER BRACKET	10-NOV-15	CG	AH

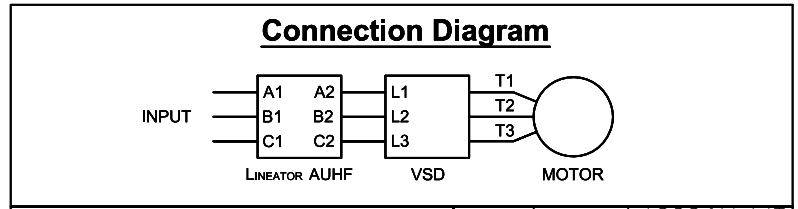

UNIT SPECIFICATIONS				INPUT	OUTPUT	APPROX. WT
HP [kW]	PHASE	VOLTS	Hz	AMPS	kW	lb [kg]
50 [37.5]	3	600	60	45	42	156 [71]

**NOTES:**  
 1. CUSTOMER IS RESPONSIBLE FOR INSTALLATION TO MEET ALL NATIONAL AND LOCAL ELECTRICAL CODES AND OTHER APPLICABLE ELECTRICAL SAFETY AUTHORITIES.  
 2. CUSTOMER IS RESPONSIBLE FOR PROPER COOLING OF FILTER COMPONENTS. ALLOWED AMBIENT: MAXIMUM 60°C, MINIMUM -40°C. A MINIMUM CLEARANCE OF 2" MUST BE ALLOWED ON BOTH RIGHT AND LEFT SIDES. PROPER VENTILATION MUST ENSURE THAT SUPPLY AIR FLOWS THROUGH THE REACTOR COILS FROM BELOW THE UNIT.

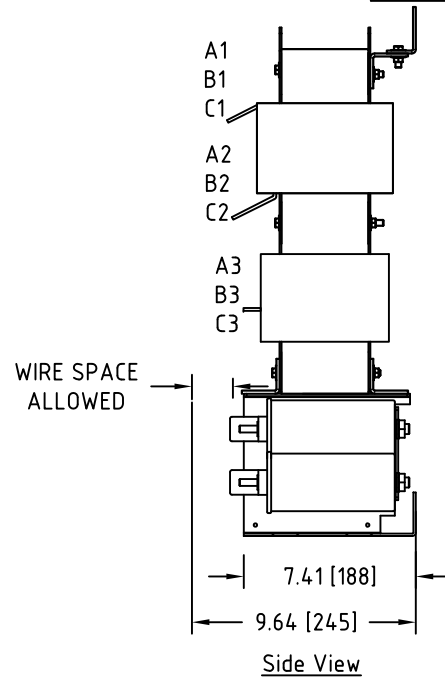
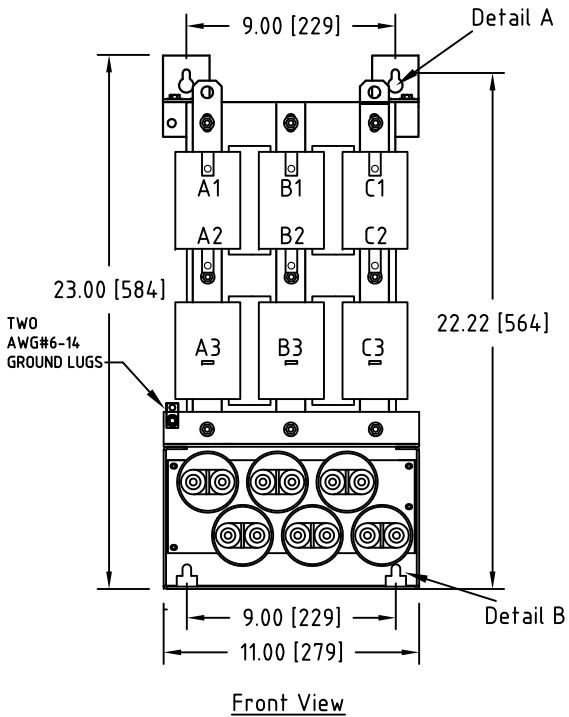
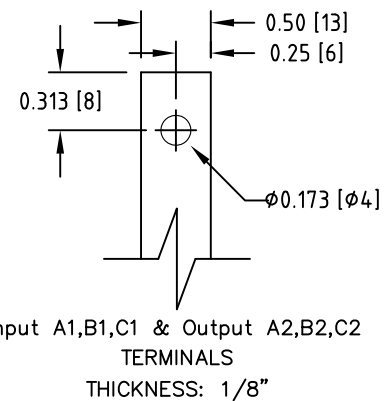
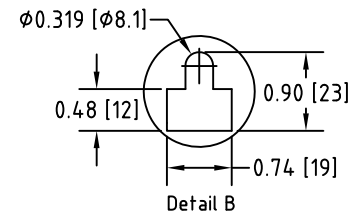
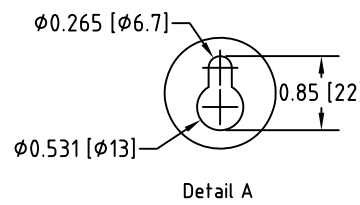
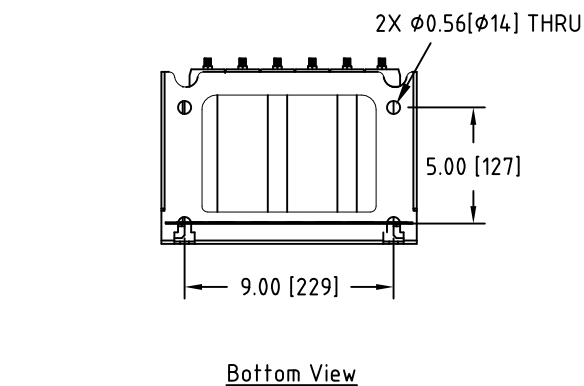

**MIRUS International Inc.** 31 Sun Pac Boulevard, Brampton, ON, Canada L6S 5P6  
 Tel:(905) 494-1120 Fax: (905) 494-1140 Toll Free: 1-888-TO MIRUS

Unless otherwise specified, dimensions are in inches and [mm].	Drawn By WXY	Date Created 20-NOV-09	Checked by YM	Approved by - date YM-20-NOV-09	Scale NTS
The information contained herein is the sole property of MIRUS International Inc. Any form of reproduction, distribution and/or disclosure of this information, all or in part, is strictly prohibited without the express written consent of MIRUS International Inc.			Title 50 HP, 600 V, 60 Hz LINEATOR™ AUHF (Panel Mount)		
Filename AUHF-50-600-60-D-E0P-A24			Revision A24	Sheet 1/1	