

REV	DESCRIPTION	DATE	BY	APP

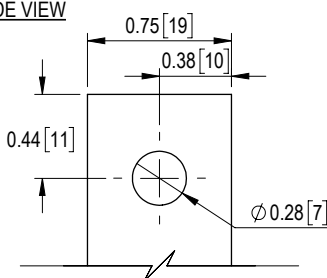

INPUT A1, B1, C1 & OUTPUT A2, B2, C2 TERMINALS THICKNESS: 1/8"

NOTES:
 1. CUSTOMER IS RESPONSIBLE FOR INSTALLATION TO MEET ALL NATIONAL AND LOCAL ELECTRICAL CODES AND OTHER APPLICABLE ELECTRICAL SAFETY AUTHORITIES.
 2. CUSTOMER IS RESPONSIBLE FOR PROPER COOLING OF FILTER COMPONENTS. ALLOWED AMBIENT: MAXIMUM 60 °C, MINIMUM -40 °C. A MINIMUM CLEARANCE OF 2" MUST BE ALLOWED ON BOTH RIGHT AND LEFT SIDES. PROPER VENTILATION MUST ENSURE THAT SUPPLY AIR FLOWS THROUGH THE REACTOR COILS FROM BELOW THE UNIT.

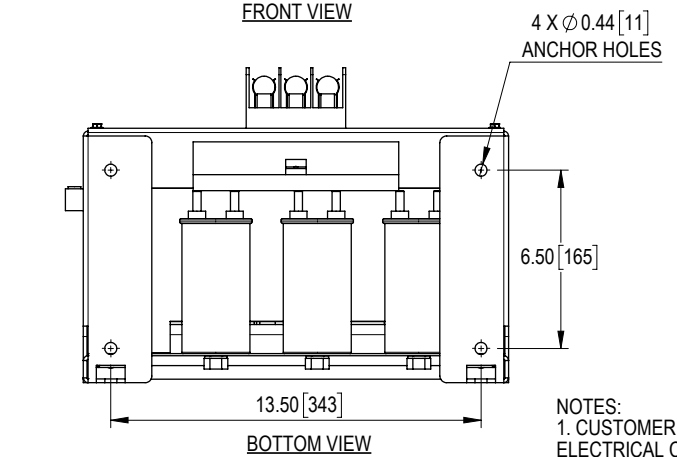
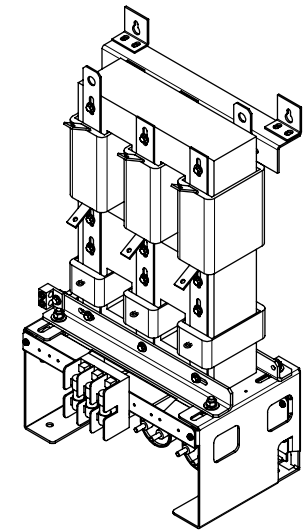
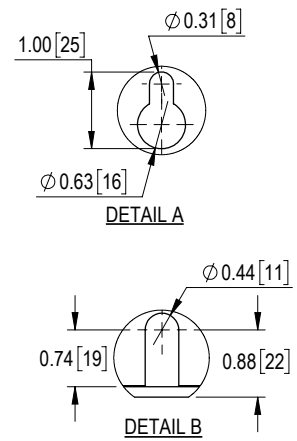
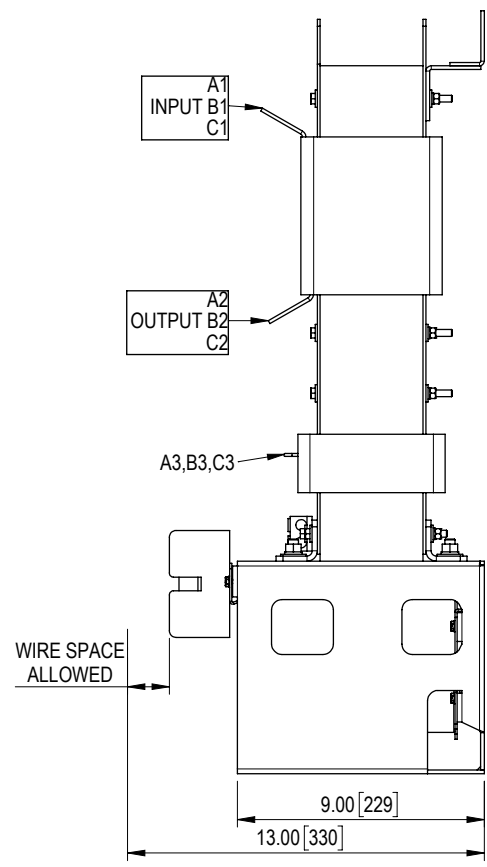
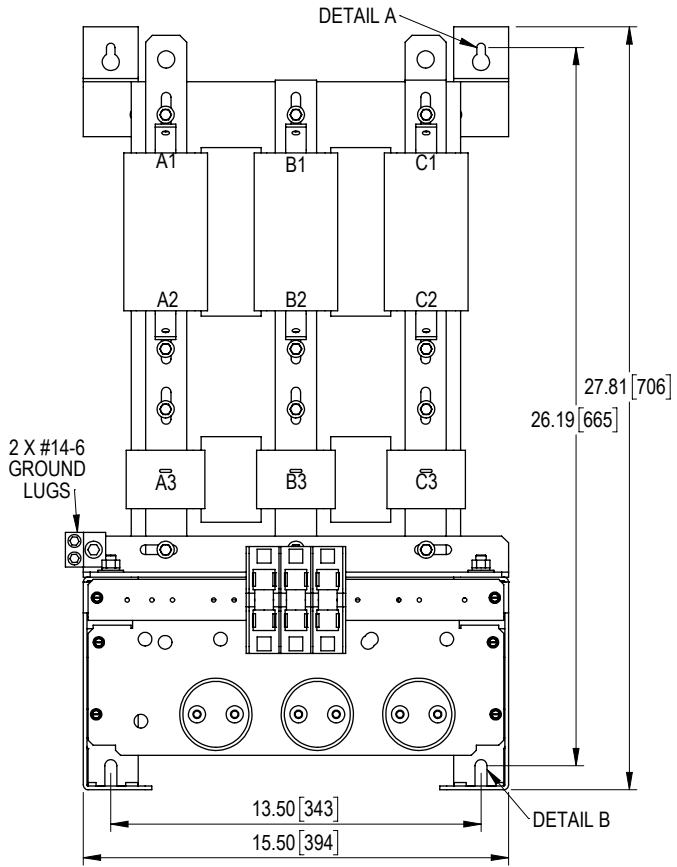
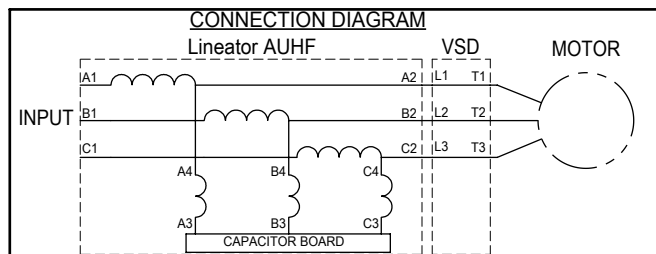

UNIT SPECIFICATIONS				INPUT AMPS	OUTPUT AMPS	OUTPUT kW	HEAT LOSS W	APPROX. WT lbs [kg]
HP [kW]	PHASE	VOLTS	Hz	69	73	51	545	225 [102]
60 [45]	3	480	60					

THE INFORMATION CONTAINED HEREIN IS THE SOLE PROPERTY OF MIRUS INTERNATIONAL INC. ANY FORM OF REPRODUCTION, DISTRIBUTION AND/OR DISCLOSURE OF THIS INFORMATION, ALL OR IN PART, IS STRICTLY PROHIBITED WITHOUT THE EXPRESS WRITTEN CONSENT OF MIRUS INTERNATIONAL INC.

DRAWN: CG APPROVED: AH
 SCALE: NTS DATE: 09-MAR-2023

MIRUS International Inc.

31 Sun Pac Boulevard, Brampton Ontario Canada L6S 5P6
 1-888-TO MIRUS www.mirusinternational.com

TITLE: 60 HP, 480 V, 60 Hz
 LINEATOR AUHF, PANEL MOUNT

ELEC FILE NO. AUHF-60-480-60-D-EX-R0	DRAWING NO. AUHF-60-480-60-D-E0P	SHT OF	REV
		1	0