

Rev. No.	Revision Note	Date	By	Checked
A16	REVISED REACTOR LAYOUT	28-AUG-2019	BDK	CG
A17	REVISED MAGNETICS DESIGN	05-JAN-2022	CG	BDK

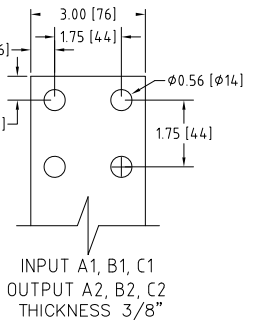

### Connection Diagram

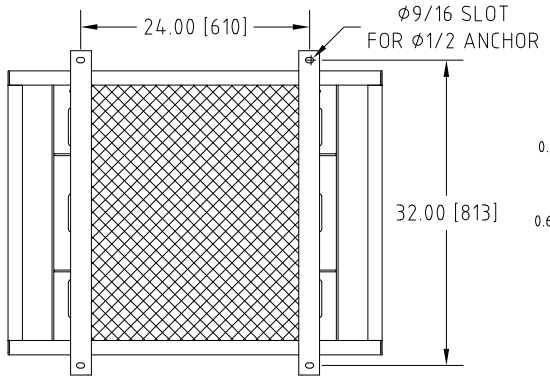
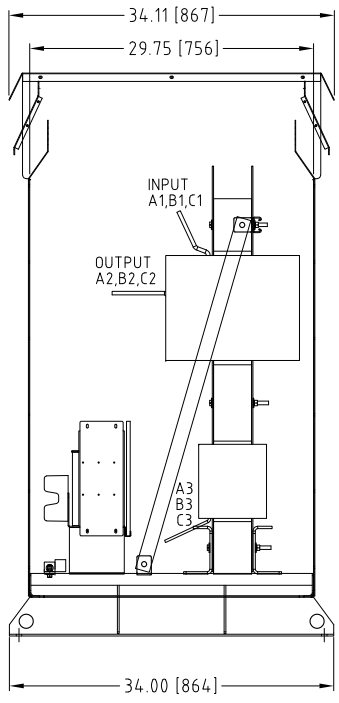
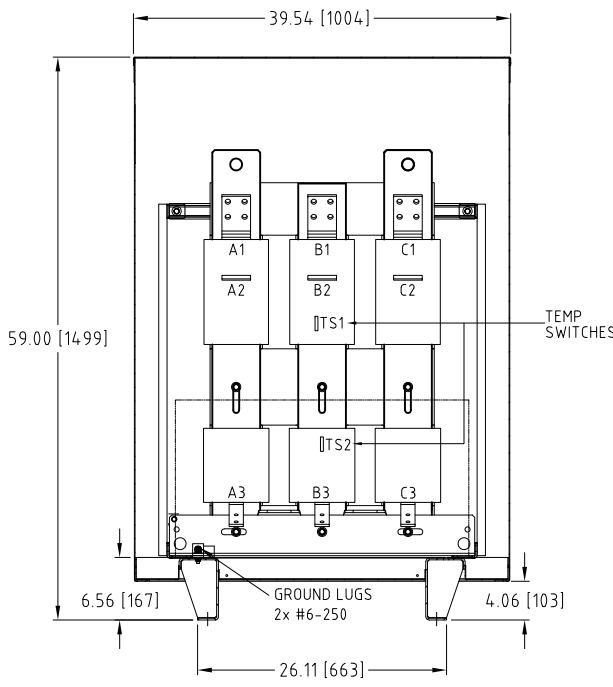
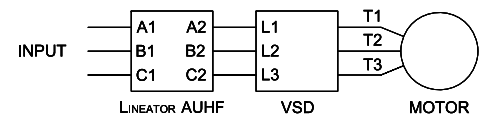

UNIT SPECIFICATIONS				INPUT	OUTPUT	APPROX. WT
HP [kW]	PHASE	VOLTS	Hz	AMPS	kW	lb [kg]
700 [500]	3	480	60	780	579	1400 [636]

NOTES:  
 1. Customer is responsible for installation to meet all national and local electrical codes and other applicable electrical safety authorities.  
 2. Type 3R Enclosure requires only front access but minimum 6" clearance should be provided at rear for proper ventilation..

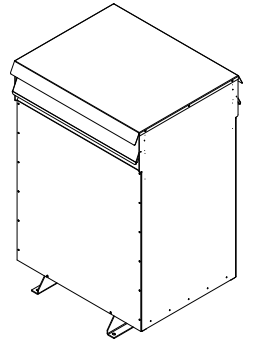
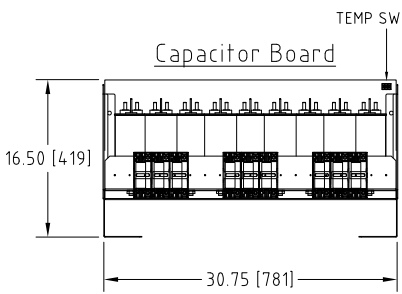
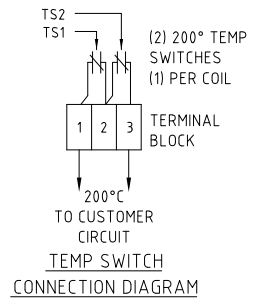

**MIRUS International Inc.** 31 Sun Pac Boulevard, Brampton, ON, Canada L6S 5P6  
 Tel: (905) 494-1120 Fax: (905) 494-1140 Toll Free: 1-888-T0 MIRUS

Unless otherwise specified, dimensions are in inches and [mm].	Drawn By EH	Date Created 17-MAY-07	Checked by YM	Approved by - date YM-17-MAY-07	Scale NTS
--	----------------	---------------------------	------------------	------------------------------------	--------------

The information contained herein is the sole property of MIRUS International Inc. Any form of reproduction, distribution and/or disclosure of this information, all or in part, is strictly prohibited without the express written consent of MIRUS International Inc.

Title 700 HP, 480 V, 60 Hz LINEATOR™ AUHF (Type-3R)	Revision A17	Sheet 1/1
Filename AUHF-700-480-60-D-E1-A17		